

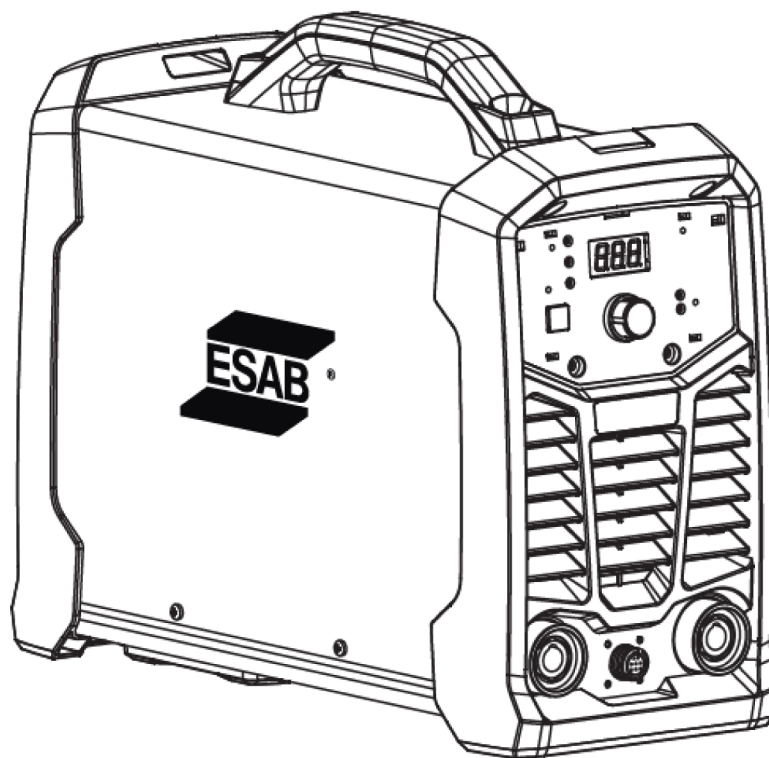

Rogue
ES 250i



Instruction manual



EU DECLARATION OF CONFORMITY

According to:

The Low Voltage Directive 2014/35/EU; The EMC Directive 2014/30/EU;
The RoHS Directive 2011/65/EU; The Ecodesign Directive 2009/125/EC

Type of equipment

Arc welding power source

Type designation

Rogue ES 250i from serial number HA410 YY XX XXXX
X and Y represents digits, 0 to 9 in the serial number, where YY indicates year of production.

Brand name or trademark

ESAB

Manufacturer or his authorised representative established within the EEA

ESAB AB
Lindholmsallén 9, Box 8004, SE-402 77 Göteborg, Sweden
Phone: +46 31 50 90 00, www.esab.com

The following EN standards and regulations in force within the EEA has been used in the design:

| | |
|-----------------------------|---|
| EN IEC 60974-1:2018/A1:2019 | Arc Welding Equipment - Part 1: Welding power sources |
| EU reg. no. 2019/1784 | Ecodesign requirements for welding equipment pursuant to Directive 2009/125/EC |
| EN IEC 60974-10:2021 | Arc Welding Equipment - Part 10: Electromagnetic compatibility (EMC) requirements |

Additional Information:

Restrictive use, Class A equipment, intended for use in locations other than residential.

By signing this document, the undersigned declares as manufacturer, or the manufacturer's authorised representative established within the EEA, that the equipment in question complies with the safety and environmental requirements stated above.

Place/Date

Signature

Gothenburg
2024-03-14

Peter Burchfield
General Manager, Equipment Solutions

TABLE OF CONTENTS

| | | |
|----------|---|-----------|
| 1 | SAFETY | 4 |
| | 1.1 Meaning of symbols | 4 |
| | 1.2 Safety precautions | 4 |
| 2 | INTRODUCTION | 7 |
| | 2.1 Overview | 7 |
| | 2.2 Equipment | 7 |
| 3 | TECHNICAL DATA | 8 |
| 4 | INSTALLATION | 10 |
| | 4.1 Location | 10 |
| | 4.2 Lifting instructions | 10 |
| | 4.3 Mains supply | 11 |
| | 4.4 Fuse sizes and minimum cable area | 11 |
| 5 | OPERATION | 12 |
| | 5.1 Connections and control devices | 12 |
| | 5.2 Connection of welding and return cables | 12 |
| | 5.3 Turning the mains power ON/OFF | 12 |
| | 5.4 Setting panel | 13 |
| | 5.5 Fan control | 13 |
| | 5.6 Thermal protection | 13 |
| | 5.7 Functions and symbols | 13 |
| | 5.8 Parameter selection | 15 |
| | 5.9 Remote control (only available in TIG mode) | 15 |
| 6 | MAINTENANCE | 16 |
| | 6.1 Routine maintenance | 16 |
| | 6.2 Cleaning instruction | 16 |
| 7 | TROUBLESHOOTING | 18 |
| 8 | ERROR CODES | 20 |
| | 8.1 Error code descriptions | 20 |
| 9 | ORDERING SPARE PARTS | 21 |
| | BLOCK DIAGRAM | 22 |
| | ORDERING NUMBERS | 23 |
| | ACCESSORIES | 24 |

1 SAFETY

1.1 Meaning of symbols

As used throughout this manual: Means Attention! Be Alert!



DANGER!

Means immediate hazards which, if not avoided, will result in immediate, serious personal injury or loss of life.



WARNING!

Means potential hazards which could result in personal injury or loss of life.



CAUTION!

Means hazards which could result in minor personal injury.



WARNING!

Before use, read and understand the instruction manual and follow all labels, employer's safety practices and Safety Data Sheets (SDSs).



1.2 Safety precautions

Users of ESAB equipment have the ultimate responsibility for ensuring that anyone who works on or near the equipment observes all the relevant safety precautions. Safety precautions must meet the requirements that apply to this type of equipment. The following recommendations should be observed in addition to the standard regulations that apply to the workplace.

All work must be carried out by trained personnel well-acquainted with the operation of the equipment. Incorrect operation of the equipment may lead to hazardous situations which can result in injury to the operator and damage to the equipment.

1. Anyone who uses the equipment must be familiar with:
 - its operation
 - location of emergency stops
 - its function
 - relevant safety precautions
 - welding and cutting or other applicable operation of the equipment
2. The operator must ensure that:
 - no unauthorised person is stationed within the working area of the equipment when it is started up
 - no-one is unprotected when the arc is struck or work is started with the equipment
3. The workplace must:
 - be suitable for the purpose
 - be free from drafts
4. Personal safety equipment:
 - Always wear recommended personal safety equipment, such as safety glasses, flame-proof clothing, safety gloves
 - Do not wear loose-fitting items, such as scarves, bracelets, rings, etc., which could become trapped or cause burns

5. General precautions:

- Make sure the return cable is connected securely
- Work on high voltage equipment **may only be carried out by a qualified electrician**
- Appropriate fire extinguishing equipment must be clearly marked and close at hand
- Lubrication and maintenance must **not** be carried out on the equipment during operation



WARNING!

Wire feeders are intended to be used with power sources in MIG/MAG mode only.

If used in any other welding mode, such as MMA, the welding cable between wire feeder and power source must be disconnected, or else the wire feeder becomes live or energized.

If equipped with ESAB cooler

Use ESAB approved coolant only. Non-approved coolant might damage the equipment and jeopardize product safety. In case of such damage, all warranty undertakings from ESAB cease to apply.

Recommended ESAB coolant ordering number: 0465 720 002.

For ordering information, see the "ACCESSORIES" chapter in the instruction manual.



WARNING!

Arc welding and cutting can be injurious to yourself and others. Take precautions when welding and cutting.



ELECTRIC SHOCK - Can kill

- Do not touch live electrical parts or electrodes with bare skin, wet gloves or wet clothing
- Insulate yourself from work and ground.
- Ensure your working position is safe



ELECTRIC AND MAGNETIC FIELDS - Can be dangerous to health

- Welders having pacemakers should consult their physician before welding. EMF may interfere with some pacemakers.
- Exposure to EMF may have other health effects which are unknown.
- Welders should use the following procedures to minimize exposure to EMF:
 - Route the electrode and work cables together on the same side of your body. Secure them with tape when possible. Do not place your body between the torch and work cables. Never coil the torch or work cable around your body. Keep welding power source and cables as far away from your body as possible.
 - Connect the work cable to the workpiece as close as possible to the area being welded.



FUMES AND GASES - Can be dangerous to health

- Keep your head out of the fumes
- Use ventilation, extraction at the arc, or both, to take fumes and gases away from your breathing zone and the general area



ARC RAYS - Can injure eyes and burn skin

- Protect your eyes and body. Use the correct welding screen and filter lens and wear protective clothing
- Protect bystanders with suitable screens or curtains



NOISE - Excessive noise can damage hearing

Protect your ears. Use earmuffs or other hearing protection.

MOVING PARTS - Can cause injuries



- Keep all doors, panels and covers closed and securely in place. Have only qualified people remove covers for maintenance and troubleshooting as necessary. Reinstall panels or covers and close doors when service is finished and before starting engine.



- Stop engine before installing or connecting unit.
- Keep hands, hair, loose clothing and tools away from moving parts.

FIRE HAZARD



- Sparks (spatter) can cause fire. Make sure therefore that there are no inflammable materials nearby
- Do not use on closed containers.

HOT SURFACE - Parts can burn



- Do not touch parts bare handed.
- Allow cooling period before working on equipment.
- To handle hot parts, use proper tools and/or insulated welding gloves to prevent burns.

MALFUNCTION - Call for expert assistance in the event of malfunction.

PROTECT YOURSELF AND OTHERS!



CAUTION!

This product is solely intended for arc welding.



CAUTION!

Class A equipment is not intended for use in residential locations where the electrical power is provided by the public low-voltage supply system. There may be potential difficulties in ensuring electromagnetic compatibility of class A equipment in those locations, due to conducted as well as radiated disturbances.

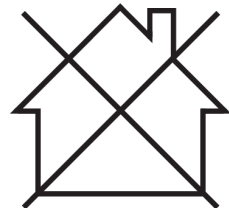

NOTE!

Dispose of electronic equipment at the recycling facility!

In observance of European Directive 2012/19/EC on Waste Electrical and Electronic Equipment and its implementation in accordance with national law, electrical and/or electronic equipment that has reached the end of its life must be disposed of at a recycling facility.

As the person responsible for the equipment, it is your responsibility to obtain information on approved collection stations.

For further information contact the nearest ESAB dealer.

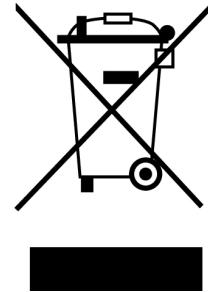

ESAB has an assortment of welding accessories and personal protection equipment for purchase. For ordering information contact your local ESAB dealer or visit us on our website.

2 INTRODUCTION

2.1 Overview

The **Rogue ES 250i** is a welding power source intended for welding with coated electrodes MMA (including cellulous electrode) and live TIG welding.

ESAB accessories for the product can be found in the "ACCESSORIES" chapter of this manual.

2.2 Equipment

The power source is supplied with:

- 2.5 m, 4×2.5 mm² input cable (no plug)
- 3 m, 25 mm² welding cable with electrode holder and 35-70 quick connector
- 2 m, 25 mm² earth cable with earth clamp and 35-70 quick connector
- Quick Start Guide
- Safety Instruction

3 TECHNICAL DATA

| Rogue ES 250i | |
|--|-------------------------------------|
| Mains voltage | 400 V \pm 15%, 3~ 50/60 Hz |
| Primary current I_{max} | |
| MMA | 17.8 A |
| TIG | 11 A |
| Idle state power (fan stop running) | |
| U _{in} 400 V | 31.7 W (VRD OFF) 20.0 W (VRD ON) |
| Setting range | |
| MMA | 10 A/20.4 V - 250 A/30 V |
| TIG | 10 A/10.4 V - 250 A/20 V |
| Permissible load at MMA | |
| 40% duty cycle | 250 A/30 V |
| 60% duty cycle | 204 A/28.1 V |
| 100% duty cycle | 158 A/26.3 V |
| Permissible load at TIG | |
| 40% duty cycle | 250 A/20 V |
| 60% duty cycle | 204 A/18.1 V |
| 100% duty cycle | 158 A/16.3 V |
| Apparent power I₂ at maximum current | 10.0 kVA |
| Active power I₂ | 8.5 kW |
| Power factor at maximum current | |
| MMA | 0.85 |
| TIG | 0.875 |
| Efficiency at maximum current | |
| MMA | 86.4% |
| TIG | 82.1% |
| Open-circuit voltage U₀ max | |
| VRD deactivated | 81 V |
| VRD activated | 13.7 V |
| Operating temperature | -10 to +40 °C (+14 to +104 °F) |
| Transportation temperature | -20 to +55 °C (-4 to +131 °F) |
| Constant sound pressure when idling | <70 db (A) |
| Dimensions l × w × h | 477 × 188 × 360 mm |
| Weight | 14.3 kg (31.5 lbs) |
| Insulation class | F |

| | |
|--------------------------|----------------------|
| | Rogue ES 250i |
| Enclosure class | IP 23 |
| Application class | S |

Mains supply, $S_{sc\ min}$

Minimum short circuit power on the network in accordance with IEC 61000-3-12.

Duty cycle

The duty cycle refers to the time as a percentage of a ten-minute period that you can weld or cut at a certain load without overloading. The duty cycle is valid for 40 °C / 104 °F, or below.

Enclosure class

The **IP** code indicates the enclosure class, i.e. the degree of protection against penetration by solid objects or water.

Equipment marked **IP23S** is intended for indoor and may be used outdoors if sheltered during precipitation.

Application class

The symbol **S** indicates that the power source is designed for use in areas with increased electrical hazard.

4 INSTALLATION

The installation must be carried out by a professional.



CAUTION!

This product is intended for industrial use. In a domestic environment this product may cause radio interference. It is the user's responsibility to take adequate precautions.

4.1 Location

Position the power source so that cooling air inlets and outlets are not obstructed.

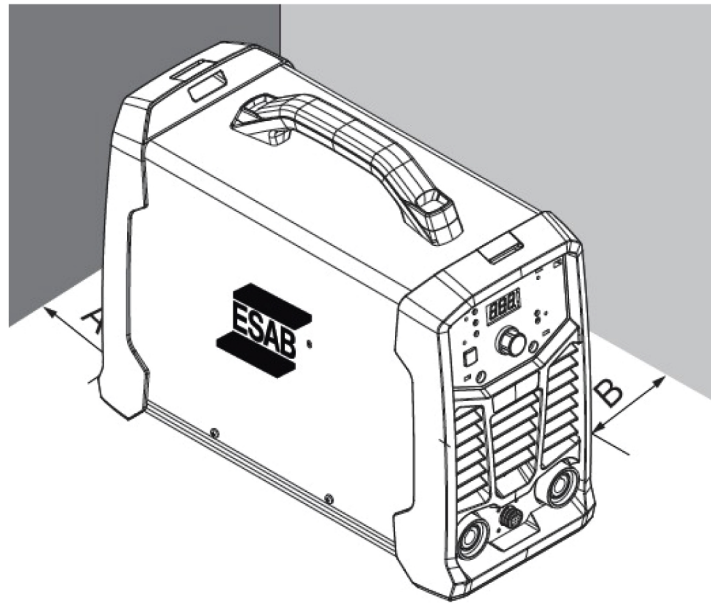

A. Minimum 200 mm (8 in.)

B. Minimum 200 mm (8 in.)

4.2 Lifting instructions

Mechanical lifting must be done with both outer handles.

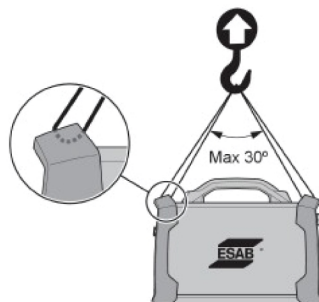

4.3 Mains supply



NOTE! Mains supply requirements

This equipment complies with IEC 61000-3-12 provided that the short-circuit power is greater than or equal to S_{scmin} at the interface point between the user's supply and the public system. It is the responsibility of the installer or user of the equipment to ensure, by consultation with the distribution network operator if necessary, that the equipment is connected only to a supply with a short-circuit power greater than or equal to S_{scmin} . Refer to the technical data in the TECHNICAL DATA chapter.

1. Rating plate with supply connection data.

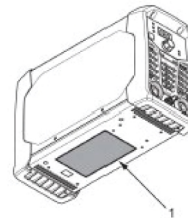

4.4 Fuse sizes and minimum cable area

| Rogue ES 250i | |
|---|--------------------------------|
| Mains voltage | 400 V \pm 15%, 3~ 50/60 Hz |
| Mains cable area | 4 \times 2.5 mm ² |
| Maximal current rating I_{max} MMA | 17.8 A |
| I_{1eff} MMA | 11 A |
| Fuse | |
| Anti-surge | 32 A |
| Type-C MCB | 32 A |
| Maximum recommended extension cord length | 100 m (330 ft.) |
| Maximum recommended extension cord size | 4 \times 2.5 mm ² |

Supply from power generators

The power source can be supplied from different types of generators. However, some generators may not provide sufficient power for the welding power source to operate correctly. Generators with Automatic Voltage Regulation (AVR) or with equivalent or better type of regulation, with rated power 20 kW, are recommended.



WARNING!
Machine should be connected to a supply with 32 A fuse or MCB.

5 OPERATION

General safety regulations for handling the equipment can be found in the "SAFETY" chapter of this manual. Read it through before you start using the equipment!



NOTE!

When moving the equipment use intended handle. Never pull the cables.



WARNING!

Electric shock! Do not touch the workpiece or the welding head during operation!

5.1 Connections and control devices

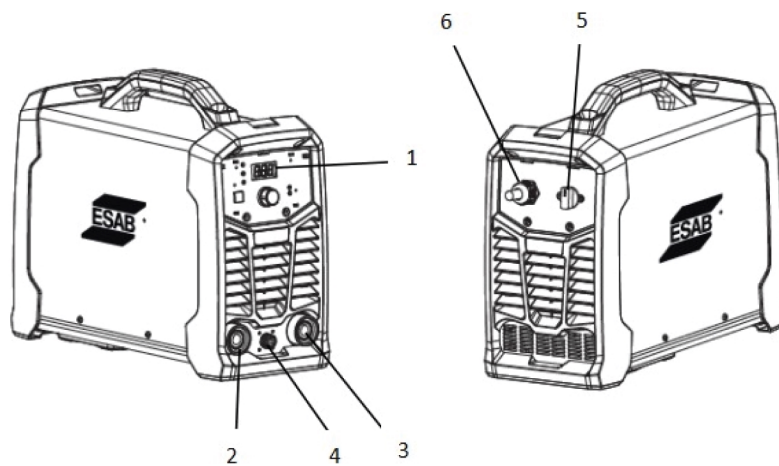

- | | |
|------------------------------|---------------------------------------|
| 1. Setting panel | 4. Connection for remote control unit |
| 2. Negative welding terminal | 5. Mains power supply switch, ON/OFF |
| 3. Positive welding terminal | 6. Mains cable |

5.2 Connection of welding and return cables

The power source has two outputs, a positive welding terminal (+) and a negative welding terminal (-), for connecting welding and return cables. The output to which the welding cable is connected depends on the welding method or type of electrode used.

Connect the return cable to the other output on the power source. Secure the return cable's contact clamp to the work piece and ensure that there is good contact between the work piece and the output for the return cable on the power source.

- For TIG welding, the negative welding terminal (-) is used for the welding torch and the positive welding terminal (+) is used for the return cable.
- For MMA welding, the welding cable can be connected to the positive welding terminal (+) or negative welding terminal (-) depending on the type of electrode used. The connecting polarity is stated on the electrode packaging.

5.3 Turning the mains power ON/OFF



CAUTION!

Do not turn OFF the power source during welding (with load).

Turn ON the mains power by turning the switch to the "ON". Turn the unit OFF by turning the switch to the "OFF" position.

Regardless the mains supply is interrupted abnormally, or the power source is switched off in the normal manner, the welding data will be stored, so it will be available next time the unit is turned ON.

5.4 Setting panel

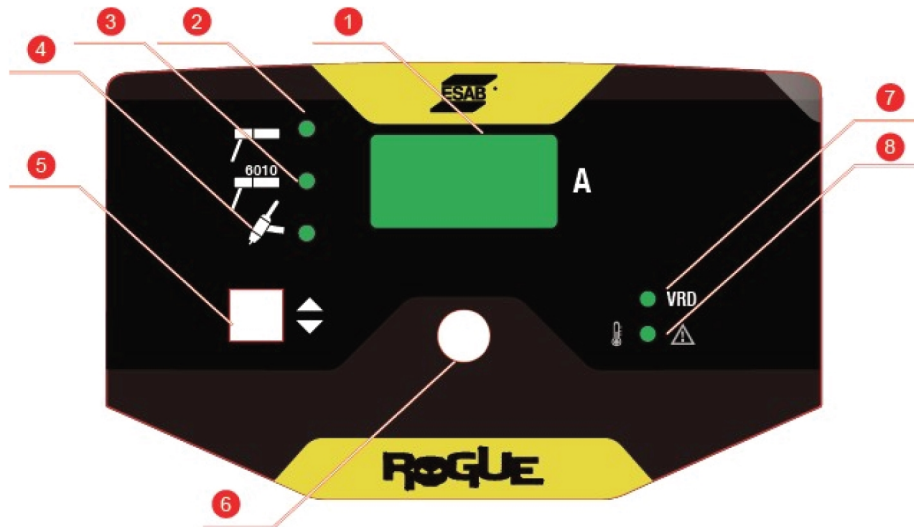

- | | |
|-----------------------|---|
| 1. Display | 5. Select welding method |
| 2. MMA indicator | 6. Welding current control knob / HS (Hot Start) / AF (Arc Force) control |
| 3. Cel-XX10 indicator | 7. VRD indicator |
| 4. Live TIG indicator | 8. Thermal protection indicator |

5.5 Fan control

The power source has an automatic thermal control. When turning ON the main power switch, the fan will run for around 6 seconds and then stop. Once welding start, the fan continues to run for a few minutes after welding has stopped while the power source switches to energy-saving mode.

5.6 Thermal protection



The power source includes thermal protection against overheating. When temperature is up to setting value, the overheating indicator on the panel will on; the welding is stopped and overheating indicator will be light and an error message shows in the display. The protection is automatically reset when the temperature has been sufficiently reduced.

5.7 Functions and symbols

MMA welding



MMA welding may also be referred to as welding with coated electrodes. Striking the arc melts the electrode, and its coating forms protective slag.

For MMA welding the power source shall be supplemented with:

- welding cable with electrode holder
- return cable with clamp

Anti stick feature

This feature operates in MMA mode. The anti stick feature senses when the electrode sticks and automatically reduces the current to prevent the Stick electrode from sticking to the work piece. This is a hidden function and is not adjustable.

Arc force**AF**

The arc force function determines how the current changes in response to variations in arc length during welding. Use a low value of arc force to get a calm arc with little spatter and use a high value to get a hot and digging arc.

Arc force applies to MMA/ 6010 mode.

Hot start**HS**

The hot start function temporarily increases the current in the beginning of the weld.

Use this function to reduce risk of insufficient fusion and electrode sticking and scratching.

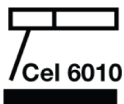
6010

Optimized arc characteristics for cellulosic electrodes such as 6010 and similar.

Live TIG

TIG welding melts the metal of the workpiece, using an arc struck from a tungsten electrode that does not melt. The weld pool and electrode are protected by shielding gas.

For Live TIG welding, the welding power source shall be supplemented with:



- a TIG torch with gas valve
- an argon gas cylinder
- an argon gas regulator
- tungsten electrode

This power source performs Live TIG start.

The tungsten electrode is placed against the workpiece. When lifted away from workpiece the arc is struck, in order to minimize the risk of tungsten contaminations the start current is limited to 65A, and will slope to the set current

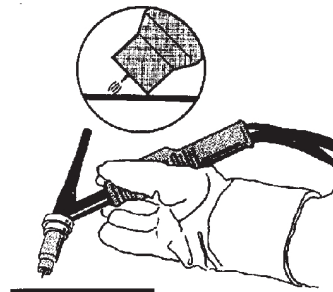
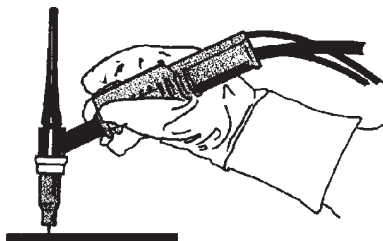
**Voltage Reduction Device (VRD)****VRD**

The VRD function ensures that the open-circuit voltage does not exceed 15 V when welding is not being carried out. This is indicated by a lit VRD indicator on the panel. When VRD function is on, the green led lit, when VRD is off the red led is lit.

VRD switch S1 is on the control PCB. It can be turned off by switching it to off position.

5.8 Parameter selection

1. **Welding mode selection:** Press button (5) to change/select the welding mode, then use control knob (6) to set welding current value.
2. **Hot start:** Press button (5) for 5s. When hot start indicator is lit (HS shows), use the control knob (6) to change hot start value. The setting range is from -10 to 10, default is 0.
“-10” means 0.2 times of user set welding current, “10” means 2 times of user set welding current, but will not exceed the maximum range 250 A.
Example: the user set welding current is 50 A, hot start range will be from 10 A (0.2*50 A, when select hot start “- 10”) to 100 A (2*50 A, when select hot start “10”).
3. **Arc force:** Press button (5) for 5s. When (AF shows) arc force indicator is lit, use the control knob (6) to change arc force value. The setting range is from -10 to 10, default is 0.
“-10” means no arc force, “10” means 2 times of user set welding current but will not exceed the maximum range 250 A.
Example: the user set welding current is 50 A, arc force range will be from 0 A (when select arc force “-10”) to 100 A (2*50 A, when select arc force “10”).

5.9 Remote control (only available in TIG mode)

MMA welding



Connect the remote control on the front panel of the power source and the remote function will be activated automatically.

The remote welding current setting is limited by the local welding current setting. For example, the local setting is 100 A, then the maximum remote current setting is 100 A.

6 MAINTENANCE

**WARNING!**

The mains supply must be disconnected during cleaning and maintenance.

**CAUTION!**

Only persons with the appropriate electrical knowledge (authorised personnel) may remove the safety plates.

**CAUTION!**

The product is covered by manufacturer's warranty. Any attempt to carry out repair work by non-authorised service centers or personnel will invalidate the warranty.

**NOTE!**

Regular maintenance is important for safe and reliable operation.

**NOTE!**





Perform maintenance more often during severe dusty conditions.

Before each use - make sure that:

- Product and cables are not damaged,
- The torch is clean and not damaged.

6.1 Routine maintenance

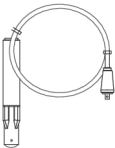
Maintenance schedule during normal conditions. Check equipment prior to every use.

| Interval | Area to maintain | | |
|----------------|--|---|--|
| Every 3 months |  Clean or replace unreadable labels. |  Clean weld terminals. |  Check or replace weld cables. |
| Every 6 months |  Clean inside equipment. Use dry compressed air with reduced pressure. | | |

6.2 Cleaning instruction

To maintain the performance and increase the lifetime of the power source it is mandatory to clean it regularly. How often depends on:

- the welding process
- the arc time

- the working environment



CAUTION!

Make sure that the cleaning procedure is done in a suitable prepared workspace.



CAUTION!

During cleaning, always wear recommended personal safety equipment, such as ear plugs, safety glasses, masks, gloves and safety shoes.

1. Disconnect the power source from the mains supply.



WARNING!

Wait at least 30 seconds for the capacitors to discharge before continuing.

2. Open the enclosure and use a vacuum cleaner to remove any accumulated dirt, metal filings, slag and loose material. Keep the shunt and lead screw surfaces clean as accumulated foreign material may reduce the welders output welding current.
3. Tighten the screws on the side panels with $3 \text{ Nm} \pm 0.3 \text{ Nm}$ (26.6 in lb. ± 2.6).

7 TROUBLESHOOTING

Perform these checks and inspections before sending for an authorised service technician.

- Check that the mains voltage is disconnected before starting any type of repair action.

| Type of fault | Possible cause | Corrective action |
|---|----------------|--|
| MMA welding problems | Connection | Check that the welding and return cables are correctly connected on the power source. |
| | | Make sure the return clamp has proper contact with the work piece. |
| | | Check that the correct electrodes and polarity are being used. For polarity, check electrode packaging. |
| | | Check that the correct current value is set. |
| | | Adjust Arc Force and Hot start. |
| TIG welding problems | | Check that the welding and return cables are correctly connected on power source. |
| | | Make sure the return clamp has proper contact with the work piece. |
| | | Make sure the TIG torch lead is connected to negative welding terminal. |
| | | Make sure the correct shielding gas, gas flow, welding current, filler rod placement, electrode diameter and welding mode on power source is used. |
| | | Make sure the gas valve on the TIG torch is on. |
| No arc | | Check that display is on to verify that the power source has power. |
| | | Check setting panel display correct values. |
| | | Check that the mains power supply switch is turned on. |
| | | Check that the mains, welding and return cables are correctly connected. |
| | | Check the mains power supply fuses. |
| Welding current is interrupted during welding | | Check whether the overheating light (thermal protection) at setting panel is on. Continue with fault type "No Arc". |
| The thermal protection trips frequently | | Make sure the recommended duty cycle for the weld current has not been exceeded. See section "Duty cycle" in the TECHNICAL DATA chapter. |
| | Poor | Make sure the air inlets or outlets are not clogged. |
| | | Clean inside machine according to routine maintenance. |

| Fault symptom | Action |
|---|---|
| Motor | |
| The motor does not turn. | Check the electrical connections. |
| | Check any error code on the control system. |
| Incorrect motor speed. | Check the settings on the control system. |
| Temperature alarm. | Stop the motor and check that the cooling unit is turned on and that there is enough flow in the cooling system. |
| | Stop the motor and check the cooling water temperature. |
| Cooling | |
| Leakage from the hoses. | Check that the hose clamps are properly tightened and that the hoses are not damaged. |
| Leakage at the weld tool. | Check that an O-ring is correctly located at the back end of the tool and that the O-ring is not damaged. |
| Leakage at leak alarm holes (see the "OPERATION" chapter). | Stop welding immediately and send for an authorised service technician! There is a dangerous internal leakage in the welding head. Do not start welding again before the welding head has been repaired by an authorised service technician! |
| Load cell | |
| The load cell does not respond. | Check the connections for the load cell. |
| | Contact your nearest ESAB service support office. |
| The load cell presents an incorrect value, i.e. the load cell accuracy is out of tolerance. | Check that the load cell or its cable has not been damaged. |
| | Calibrate the load cell to bring the accuracy back into tolerance according to instructions for the specific control system. |
| Bearings | |
| Noise from the bearings. | Stop welding and send for an authorised service technician. One or both bearings need to be replaced. |
| Vibrations from the bearings. | Stop welding and send for an authorised service technician. One or both bearings need to be replaced. |
| Axial play in bearing more than 0.03 mm. | Send for an authorised service technician. The bearing needs to be replaced. |

8 ERROR CODES

The error code is used to indicate that a fault has occurred in the equipment. Errors are indicated by the text "E-" followed by the error code number shown in the display.

If several errors have been detected only the code for the last occurring error is displayed.

8.1 Error code descriptions

Error codes that the user can handle are listed below. If any other error code appears, contact an authorised ESAB service technician.

| Error code | Description |
|------------|--|
| E-01 | <p>Temperature fault or over loaded</p> <p>The temperature of the power source is too high. A LED indicating temperature fault is also lit on the panel. A temperature fault is indicated by the overheating indicator on the control panel.</p> <p>The error code will automatically disappear and the LED indicating temperature fault will be turned off when the power source has cooled down and it is ready for use again. If the error persists, contact a service technician.</p> |
| E-02 | <p>Over voltage protection</p> <p>The power supply to the power source is too high voltage (more than 480 V). Make sure the power supply is stable, and the input voltage is in the range of 320 V - 480 V.</p> |
| E-03 | <p>Under voltage protection</p> <p>The power supply to the power source is too low voltage (less than 320 V). Make sure the power supply is stable, and the input voltage is in the range of 320 V - 480 V.</p> |
| E-13 | <p>Communication fault</p> <p>The communication between main control PCBA to display PCBA is lost. Check the if nay loss in the cable between these two PCBA. If the error persists, contact a service technician.</p> |
| E-20 | <p>Power supply phase loss protection</p> <p>The power supply to the power source loses any phase. One phase is lost during 3-phase operation. Make sure the power supply is stable, all leads are connected, that the mains voltage (all 3 phases) are OK and restart the system. If the error persists, contact a service technician.</p> |

9 ORDERING SPARE PARTS



CAUTION!

Repair and electrical work should be performed by an authorised ESAB service technician.
Use only ESAB original spare and wear parts.

The **Rogue ES 250i** is designed and tested in accordance with the international and European standard **IEC 60974-1**. On completion of service or repair work, it is the responsibility of the person(s) performing the work to ensure that the product still complies with the requirements of the above standards.

Spare parts and wear parts can be ordered through your nearest ESAB dealer, see [esab.com](https://www.esab.com). When ordering, please state product type, serial number, designation and spare part number in accordance with the spare parts list. This facilitates dispatch and ensures correct delivery.

APPENDIX

BLOCK DIAGRAM

From serial number HA410YY-XXXXXX

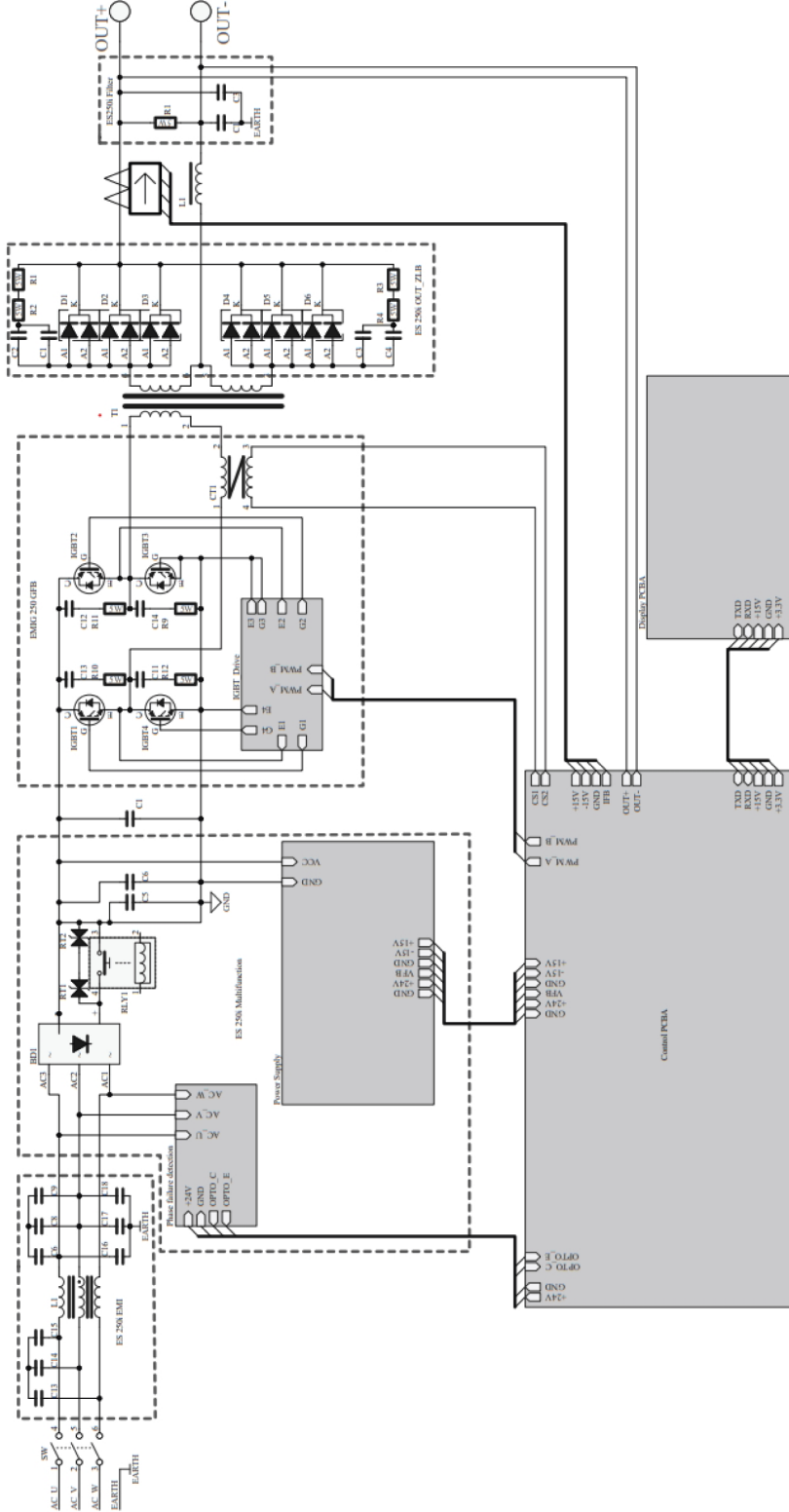

ORDERING NUMBERS

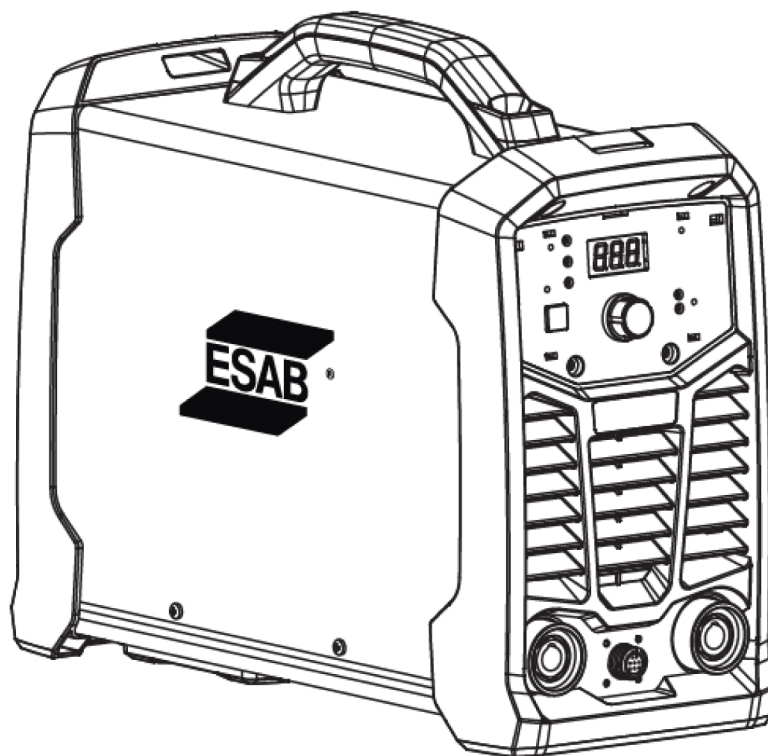

| Ordering number | Denomination | Type | Notes |
|-----------------|--------------------|---------------|-------|
| 0700 500 250 | Power source | Rogue ES 250i | |
| 0700 500 * | Instruction manual | Rogue ES 250i | |
| 0700 500 265 | Spare parts list | Rogue ES 250i | |

The three last digits in the document number of the manual show the version of the manual. Therefore they are replaced with * here. Make sure to use a manual with a serial number or software version that corresponds with the product, see the front page of the manual.

Technical documentation is available on the Internet at: www.esab.com

ACCESSORIES

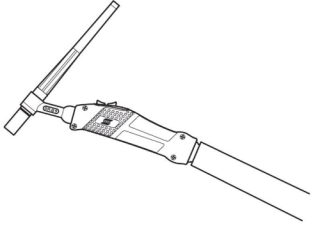
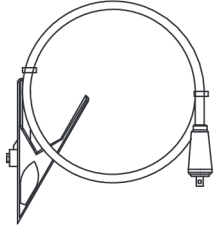
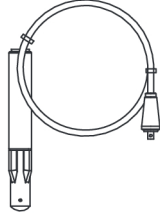
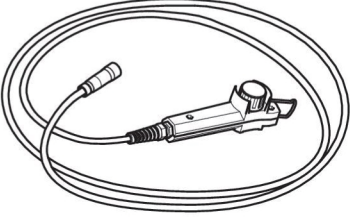
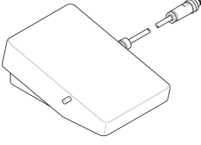
| | | |
|--------------------------------------|--|---|
| <p>0700 025 514 0700 025 522</p> | <p>SR-B 17 V, OKC 50, 4 m SR-B 26 V, OKC 50, 4 m</p> |  |
| <p>Return cable kits</p> | |  |
| <p>0700 006 901 0700 006 885</p> | <p>Return cable kit, OKC 50, 3 m Return cable kit, OKC 50, 5 m</p> | |
| <p>0700 006 900</p> | <p>Electrode holder Handy, 200 A with 25 mm², 3 m, OKC 50</p> |  |
| <p>0700 500 084</p> | <p>Remote control, MMA 4</p> |  |
| <p>W4014450</p> | <p>Foot pedal with 4.5 m (15 ft.) cable, 8-pin</p> |  |



A WORLD OF PRODUCTS AND SOLUTIONS.



For contact information visit <http://esab.com>

ESAB AB, Lindholmsallén 9, Box 8004, 402 77 Gothenburg, Sweden, Phone +46 (0) 31 50 90 00

manuals.esab.com

