

# STEELBEAST®

**JEI**  
Solutions  
Built for Industry

## ABM-30 AUTO FEED TRACKLESS BEVELLER

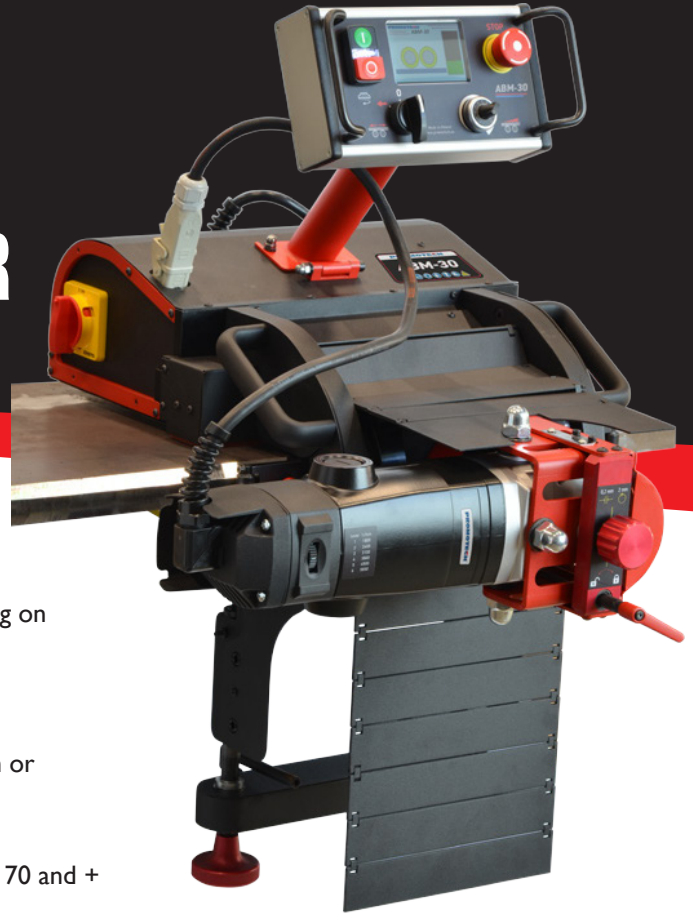

### THE STEELBEAST® ABM-30

The ABM-30 portable beveling machine performs auto feed beveling on steel plates on top, face and bottom edges.

The beveller needs no track to move along steel plate to produce accurate high-quality double-side bevels without thermal distortion or creation of heat affected zone on plate thickness range 8-60 mm.

The ABM-30 features an infinitely adjustable bevel angle between  $-70$  and  $+70$  degrees and is capable of producing bevels up to 30 mm wide.

It also allows for facing in both directions with the milling head depth of 1 mm.

### FEATURES AND BENEFITS:

- Needs no track to travel in both directions with feed speed up to 2 m/min
- 4 wheels feed drive eliminates hard physical work of the operator
- produces double-side bevels without having to flip the plate enhancing safety and reducing material handling time and expense
- Edge to Edge working range
- Semi-automatic feed stop at end of the metal sheet
- Variable spindle speed
- Bevel width up to 30 mm (1-3/16")
- Variable angle ( $-70^{\circ}+70^{\circ}$ )
- Max. plate thickness up to 60 mm
- Innovative, robust chip protection solution

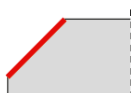

Top beveling



Facing off



Bottom beveling



Plate thickness max 60 mm

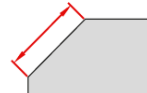

Bevel width up to 30 mm



Bevel angle between  $-70$  and  $70^{\circ}$

CALL 01706 229 490 TO BOOK YOUR DEMONSTRATION NOW OR VISIT [WWW.STEELBEAST.CO.UK](http://WWW.STEELBEAST.CO.UK)



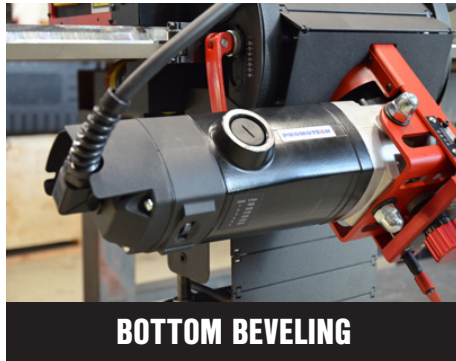

ABM-30 TECHNICAL SPECIFICATION	
Voltage	1~ 200-240 V, 50/60 Hz 1~ 110-120 V, 50/60 Hz
Power	2200 W
Spindle rotational speed (without load)	1800-5850 rpm
Feed speed	0-2 m/min (0-6.5 ft/min)
Bevel angle ( $\beta$ , Fig. 1)	From -70° to 70°*
Maximum bevel width (b, Fig. 1)	30 mm (1.18")
Sheet thickness	8-60 mm (0.3-2.3")
Required ambient temperature	5-40°C
Weight	53 kg (116.8 lbs)

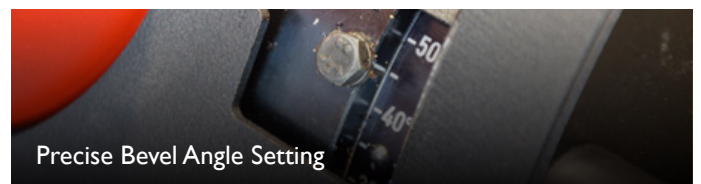

## CONTROL PANEL:

- Feed direction indication
- Material detection
- Bar graph for motor load illustration
- Visual warning signals

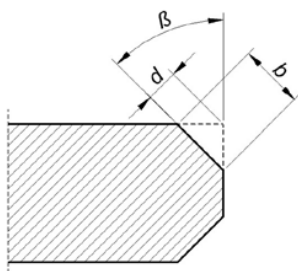

$\beta$	0°	15°	37.5°	45°	60°	70°
b	30 mm (1.18")	30 mm (1.18")	30.5 mm (1.2")	30 mm (1.18")	30 mm (1.18")	31 mm (1.22")

CALL **01706 229 490** TO BOOK YOUR DEMONSTRATION NOW OR VISIT **WWW.STEELBEAST.CO.UK**

## DIMENSIONS:

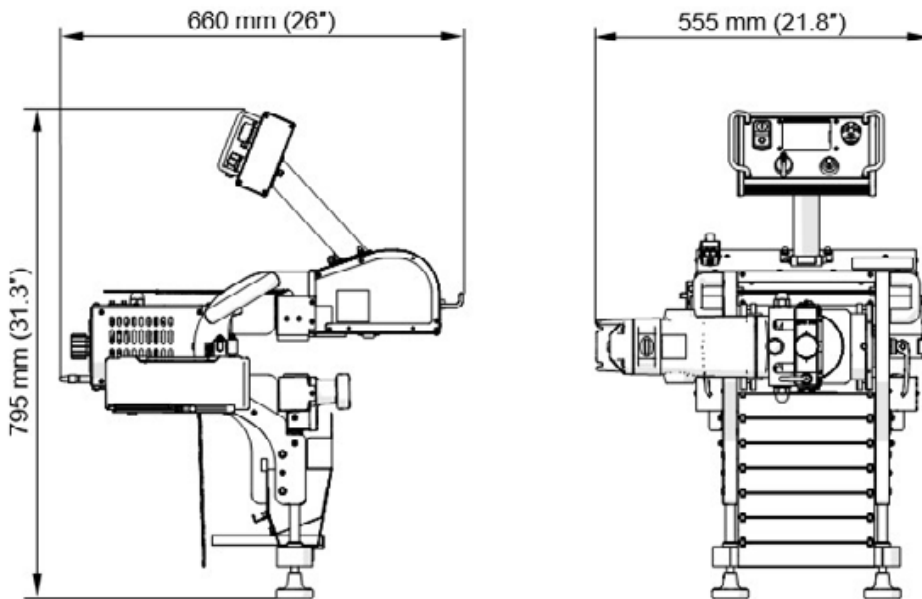

## SHIPPING SET:

- Beveling machine (with a milling head and 5 cutting inserts)
- Tool box
- Drift
- 10 mm hex wrench
- 3 mm hex wrench
- 8 mm combination wrench
- Grease for screws Molykote 1000 (5 g, 0.17 oz)
- Operator's Manual

## ADDITIONAL ACCESSORY:

Transportation and storage trolley:



CALL **01706 229 490** TO BOOK YOUR DEMONSTRATION NOW OR VISIT **WWW.STEELBEAST.CO.UK**